

# the S&P Rechargeable™

Instruction Book – LSP240



**Breville®**

# Contents

Limited Product Warranty	2
Breville® Recommends	
Safety First	2
Important Safeguards	2
Components	8
Functions	9
Care & Cleaning	12

## LIMITED PRODUCT WARRANTY

Breville's warranty for this product covers the repair or replacement if it's found to be defective due to faulty materials, workmanship, or function within the warranty period. All legal warranty rights under applicable national legislation will be respected and will not be impaired by our warranty. For details on length of warranty, to obtain a printed copy or to read full terms and conditions please scan



QR149

the QR code or visit [www.breville.com](http://www.breville.com). Alternatively, call the Breville Service Centre (see back cover for contact details).

# BREVILLE® RECOMMENDS SAFETY FIRST

**At Breville we are very safety conscious. We design and manufacture consumer products with the safety of you, our valued customer, foremost in mind. In addition, we ask that you exercise a degree of care when using any electrical appliance and adhere to the following precautions.**

## IMPORTANT SAFEGUARDS

**Read all instructions before use and save for future reference.**

- Carefully read all instructions before operating the salt & pepper mills for the first time and save for future reference.
- Always ensure the salt & pepper mills are properly assembled before use. Follow the instructions provided in this instruction book.

- Remove and safely discard any packaging material and promotional labels before using the salt & pepper mills for the first time.
- Do not immerse the motor body, USB cable or USB power adaptor (not included) in water or any other liquid.
- Switch off the power outlet and disconnect the USB cable before assembling or cleaning.
- Do not use the salt & pepper mills while connected to the USB cable and power adaptor.
- Switch off the power outlet, remove the USB power adaptor (not included) and unplug the USB cable from the salt & pepper mills charging dock before removing attachment or cleaning.
- Do not leave the salt & pepper mills unattended when in use. Young children should be supervised to ensure they do not play with the salt & pepper mills. Keep out of reach of children.
- The salt & pepper mills are not intended for use by young children or infirm persons without supervision.
- The salt & pepper mills are not intended for use by persons (including children) with reduced physical, sensory or mental capabilities, or lack experience and knowledge, unless they are supervised or have been given instruction concerning use of the salt & pepper mills, by a person responsible for their safety.
- Do not carry the salt & pepper mills charging dock by the USB cable; instead, make sure to lift or move the salt & pepper mills by holding both the motor body and the charging dock.
- Do not pull the USB cable itself when disconnecting the cable from the USB port; instead, grasp the plastic part of the USB plug and pull it to disconnect.
- Ensure that the USB port is dry and free of any debris before inserting USB connector to the port.

- Do not twist or pull the USB cable around sharp edges or corners.
- Do not let the USB cable hang over the edge of a table or counter, touch hot surfaces or become knotted.
- Be aware of the risk that the USB charging port may be short circuited by metal objects.
- Recommended ambient temperature range for charging the battery of the salt & pepper mills is 10°C to 40°C.
- Always make sure the salt & pepper mills are completely and properly assembled before operating.
- Do not operate the salt & pepper mills continuously for more than 1 minute. Allow motor to rest for 1 minute between each use.
- Do not use the salt & pepper mills with wet hands.
- Do not store the salt & pepper mills in area with high humidity, wet or area with high traffic of steam.
- Recommended temperature range for storage of the salt & pepper mills is 10 to 30°C.
- Do not place the salt & pepper mills in direct sunlight. Colour fading and discolouration may occur when the salt & pepper mills are consistently exposed to UV light.
- Keep the salt & pepper mills clean. Follow cleaning instructions provided in this book. Refer to Care & Cleaning section.
- Before disposing of the salt & pepper mills, remove and safely dispose of its lithium-ion battery. Disconnect from mains power supply before removing battery.
- The battery is non-replaceable and should be safely disposed of according to local waste management guidelines.
- Do not use the salt & pepper mills if they are damaged or have malfunctioned.
- Do not use the salt & pepper mills over cooking. Moisture from the steam can clog the mills grinding mechanism.
- The battery must be removed from the appliance before it is scrapped.

## **IMPORTANT SAFEGUARDS FOR ALL ELECTRICAL APPLIANCES**

- Fully unwind the USB cable before use.
- Do not let the USB cable hang over the edge of a bench or table, touch hot surfaces or become knotted.
- To protect against electric shock, do not immerse the USB cable, USB adaptor (not included) or appliance in water or any other liquid or allow moisture to come in contact with the part, unless it is recommended in the cleaning instructions.
- Children should be supervised to ensure that they do not play with the appliance.
- It is recommended to regularly inspect the appliance. To avoid a hazard do not use the appliance if USB cable, USB adaptor (not included) or appliance becomes damaged in any way. Return the entire appliance to the nearest authorised Breville Service Centre for examination and/or repair.
- The appliance is not intended for use by persons (including children) with reduced physical, sensory or mental capabilities, or lack of experience and knowledge, unless they have been given supervision or instruction concerning use of the appliance by a person responsible for their safety.
- Any maintenance other than cleaning should be performed at an authorised Breville Service Centre.
- This appliance is for household use only. Do not use this appliance for anything other than its intended use. Do not use in moving vehicles or boats. Do not use outdoors.  
**Misuse may cause injury.**
- The installation of a residual current device (safety switch) is recommended to provide additional safety protection when using electrical appliances. It is advisable that a safety switch with a rated residual operating current not exceeding 30mA be installed in the electrical circuit supplying the appliance. See your electrician for professional advice.

- During electrical storms, the appliance should be disconnected from the power source at the wall socket to prevent any electrical surges that may arise during the storm and which may inadvertently cause damage to the appliance and its electronic componentry.
- Always turn the appliance to the off position by switching off at the power outlet and unplugging from the power outlet.
- Before cleaning, always turn the appliance to the off position, switch off at the power outlet, unplug at the power outlet and remove the USB cable, if detachable, from the appliance and allow all parts to cool.
- Do not place this appliance on or near a heat source, such as a hot plate, oven or heaters.
- Position the appliance at a minimum distance of 20cm away from walls, curtains and other heat or steam sensitive materials and provide adequate space above and on all sides for air circulation.

## **PLEASE READ THE FOLLOWING BEFORE CHARGING THE SALT & PEPPER MILLS USING A USB POWER ADAPTOR**

- Only use an electrical safety compliant USB power adaptor with the following output requirements: DC 5V 1A and Regulatory Compliance Mark .
- Supply the appliance at safety extra low voltage.
- Fully unwind the USB cable before charging.
- Connect the salt & pepper mills charging dock using the USB cable provided.
- Plug the USB power adaptor directly into the power outlet.
- Do not use in conjunction with an extension cord.
- To protect against electric shock, do not immerse USB cable, USB power adaptor or appliance in water or any other liquid.
- Do not operate the salt & pepper mills with a damaged USB power adaptor.

- Regularly inspect the salt & pepper mills, USB cable and USB adaptor (not included) for damage. If faulty, return the salt & pepper mills and USB cable provided to the nearest authorised Breville service centre for examination and/or repair.
- During electrical storms, while charging, disconnect the salt & pepper mills from the power outlet to prevent any electrical surges damaging the mills and its electronic components.

**FOR HOUSEHOLD USE ONLY  
SAVE THESE INSTRUCTIONS**

# COMPONENTS

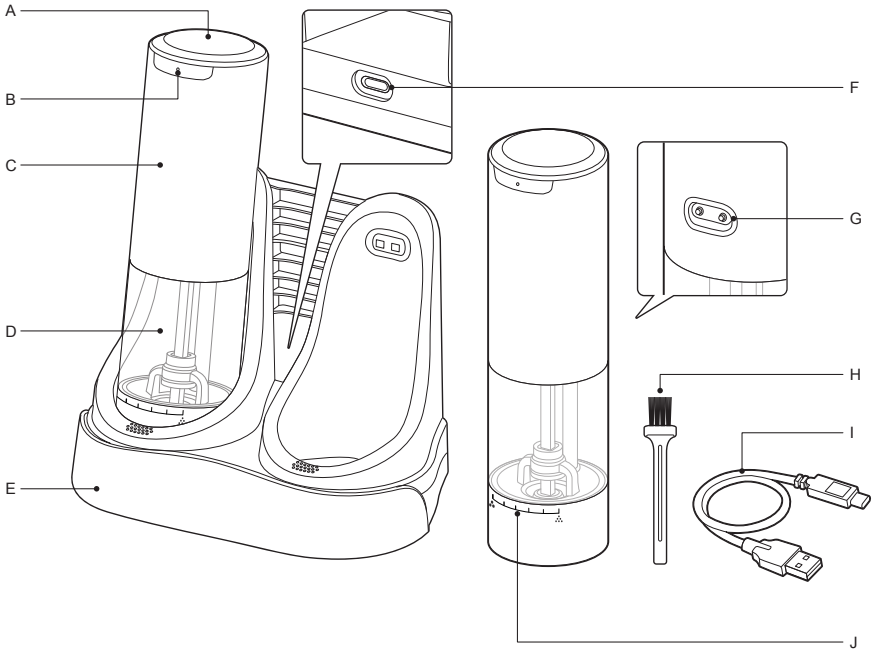

- A. One Touch Grinding Button
- B. Charging Light
- C. Motor Body
- D. Salt & Pepper Compartment / Viewing Window (BPA free\*)
- E. Charging Dock (storage base & charging component)
- F. USB-C Charging Port
- G. Charging Connector
- H. Cleaning Brush
- I. USB-A to USB-C Charging Cable
- J. Grind Control

\*Breville® makes its BPA free claim for this product based on independent laboratory testing performed for all the food contact plastic materials of the product per Commission Regulation (EU) 2024/3190.

## Not Shown

- Built-in Grinding Light

# FUNCTIONS

## BEFORE FIRST USE

1. Remove all promotional stickers and packaging material.
2. Check for any missing or damaged parts as per the components list.
3. Clean all parts according to the Care & Cleaning section.
4. To activate the salt & pepper mills for the first time:
  - Connect the supplied USB-C charging cable to a USB power adaptor (not included).
  - Plug the adaptor into a power outlet.
  - Insert the USB-C connector into the charging dock's rear port.
  - Place the mills onto the charging dock, ensuring the charging connectors are properly aligned.
  - The charging lights on the mills will illuminate in red to indicate the battery is charging.

### NOTE

The salt & pepper mills come with a USB charging cable only. A USB power adaptor is not included.

### NOTE

- To prolong lithium-ion battery longevity, it is best to avoid extreme temperatures (both hot and cold), keep in a cool, dry place when not in use, avoid complete discharge, maintain battery at a charge between 20% and 80% charge to increase life span.

- Fully charge the grinder batteries before the first use and avoid letting it fully drain to maximise battery longevity.

## CHARGING THE BATTERY

The salt & pepper mills are pre-programmed with a low battery reminder. When battery level is low, the charging light will flash red during operation.

1. Ensure that all stickers and packaging material are removed from the motor body.
2. Connect the supplied USB charging cable USB-A connector to a USB power adaptor (not included) with a USB-A port, then insert the USB charging cable USB-C connector into the charging dock's rear port.
3. Plug the USB power adaptor (not included) into a 230V or 240V power outlet.
4. Alternatively, if available, connect the USB charging cable directly to a USB charging outlet.
5. Place the mills onto the charging dock, ensuring the charging connectors are properly aligned and securely connected.
6. The charging lights on the mills will illuminate in red to indicate the battery is charging.
7. When the charging lights are solid white, the mills are fully charged.
8. Once the mills are fully charged, unplug the USB charging cable from both the USB power adaptor and the charging dock.

Charging light	Meaning
Red (flashing during use)	Low battery
Red (flashing)	Charging
White (solid)	Fully charged

### NOTE



- The mills will not operate while charging.
- Charging from empty to full takes approximately 2.5 hours using a DC 5V 1A USB power adaptor.

### NOTE

Store the mills at room temperature to maintain battery health and longevity. Extreme temperatures can affect the performance and lifespan of lithium-ion batteries.

## FILLING THE MILLS



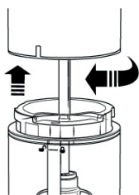

These mills are designed exclusively for grinding salt and pepper. Do not use them to grind other spices or food items. Some varieties may not be suitable for use in these mills.

- To open the salt or pepper compartment, hold the stainless steel body of the mill firmly in one hand. With your other hand, rotate the lower compartment anti-clockwise until the  symbol aligns with the .

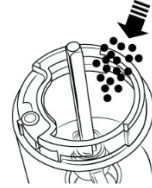

- Pour the desired amount of salt or pepper into the compartment. Do not overfill.



- To reassemble, align the  symbol on the stainless steel mill body with the  on the compartment. Rotate the mill body clockwise until the  symbol aligns with the  to secure.

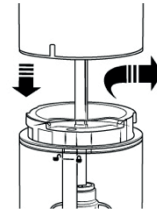

## ADJUSTING THE GRIND

The salt & pepper mills feature adjustable grind control, allowing you to select a fine or coarse texture to suit your preference.

To adjust the grind size, simply rotate the lower compartment of the mill:

- Clockwise for a finer grind.
- Anti-clockwise for a coarser grind.

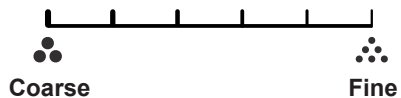

## OPERATING THE MILLS

- Hold the mill directly over the food to be seasoned, press and hold the one touch operation button at the top of the mill.
- While the mill is operating, the grinding light at the base of the grinder will illuminate.
- To stop grinding, release the one touch button.
- When not in use, place the mills back onto the charging dock for storage.

### **WARNING**

Do not use the mills over cooking surfaces. Moisture from the steam can clog the mills grinding mechanism.

Do not invert the grinder for extended periods while filled. Seasoning grains may enter the battery compartment and cause corrosion.

### **NOTE**

If the adjuster loosens during use, it may be due to pepper grains lodged in the ceramic burr. To resolve this, activate the grinder briefly to dislodge the grains, and continue adjusting as needed. Alternatively, use the cleaning brush to clear the grinder.

# CARE & CLEANING

Before cleaning, ensure the USB charging cable is unplugged from both the USB power adaptor and the charging dock.

- To clean the outside of the salt & pepper mills, wipe the stainless steel housing and the charging dock with a soft, damp cloth and dry thoroughly.

## NOTE

Do not use steel wool, scouring pads or abrasive cleaners on the salt & pepper mills, as they will damage the stainless steel housing.

- The charging base can be disassembled for cleaning.
1. Hold both sides of the base with two hands and push the charging component backward (Fig. 1) until a 'click' is heard to remove it.
  2. After cleaning and ensuring the base is thoroughly dry, align the hooks with the slots and push the charging component forward (Fig. 2) until it clicks securely into place.

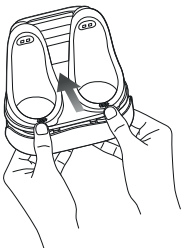

Fig. 1

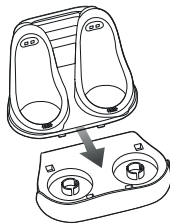
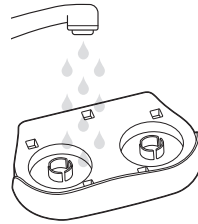

Fig. 2

## WARNING

- Only the storage base can be washed directly.
- Do not wash the charging component.
- Ensure the base is dried thoroughly before reassembling.



- To clean the inside of the salt and pepper compartment, empty out the contents of the compartment and use the supplied cleaning brush or another small dry brush to clear out any remaining salt or pepper.

## NOTE

Do not wash or soak the salt & pepper mills in water or any other liquid. Do not allow water or any other liquid to enter the motor body or charging dock as this may result in damage or injury.

## STORAGE

Before storing, unplug the USB charging cable from both the USB power adaptor and the charging dock, and ensure all parts of the salt & pepper mills and accessories are clean and dry.

Put the mills back onto the charging dock for storage. Ensure the charging dock is disconnected from power.

The salt & pepper mills should be stored in a dry and cool location. This will help to prevent the contents from clumping.

If the salt and pepper mills are not being used for an extended period, the contents inside the mills compartment should be removed and stored in an airtight container until their expiry date.

## BATTERY DISPOSAL

Before disposing of the salt & pepper mills, the lithium-ion battery must be removed from the appliance. The batteries in the salt & pepper mills are not replaceable by the end user.

Different regions have specific regulations regarding the disposal of lithium-ion batteries. Check your local waste management authority or environmental agency for guidelines on lithium-ion battery and e-waste collection.

## DO NOT DISPOSE OF THE BATTERY IN YOUR HOME RUBBISH BINS.

### WARNING

The battery must be removed from the appliance before it is scrapped.

# Notes

# Note

# Breville Service Centre

## **Australian Customers**

**Phone:** 1300 139 798

**Web:** [www.breville.com](http://www.breville.com)

## **New Zealand Customers**

**Phone:** 0800 273 845

**Web:** [www.breville.com](http://www.breville.com)

# **Breville®**

**Master Every Moment™**

Breville, the Breville Logo, and S&P Rechargeable are trademarks of Breville Pty Ltd ("Breville") and Breville's products are distributed in Australia and New Zealand under license.

Copyright Breville Pty. Ltd. 2025.

Due to continued product improvement, the products illustrated/photographed in this booklet may vary slightly from the actual product.