

the Barista Pro™

Instruction Book - BES878



Breville®



Contents

- 2 Breville Recommends Safety First
- 2 Limited Product Warranty
- 7 Components
- 9 Features
- 10 Assembly
- 12 Functions
- 19 Care & Cleaning
- 23 Troubleshooting



Limited Product Warranty

Breville's warranty for this product covers the repair or replacement if it's found to be defective due to faulty materials, workmanship, or function within the warranty period. All legal warranty rights under applicable national legislation will be respected and will not be impaired by our warranty. For details on length of warranty, to obtain a printed copy or to read full terms and conditions please scan the QR code or

visit www.breville.com

Alternatively, call the Breville Service Centre (see back cover for contact details).



QR149

BREVILLE RECOMMENDS SAFETY FIRST

At Breville we are very safety conscious. We design and manufacture consumer products with the safety of you, our valued customer, foremost in mind. In addition we ask that you exercise a degree of care when using any electrical appliance and adhere to the following precautions.

IMPORTANT SAFEGUARDS

READ ALL
INSTRUCTIONS BEFORE
USE AND SAVE FOR
FUTURE REFERENCE

- Carefully read all instructions before operating and save for future reference.
- Remove any packaging material and promotional labels or stickers before using the Barista Pro™ for the first time.
- To eliminate a choking hazard for young children,

remove and safely discard the protective cover fitted to the power plug of this appliance.

- Do not place the product near the edge of a bench or table during operation. Ensure the surface is level, clean and free of water and other substances.
- Do not use the product on a sink drain board.
- Do not operate the appliance if it is in an enclosed space, or within a cupboard.
- Do not let the cord hang over the edge of a bench or table, or become knotted. Keep away from hot gas or electric burner, or where it could touch a heated oven.
- This appliance can be used by children aged from 8 years and above if they have been given supervision or instruction concerning use of the appliance in a safe way and understand

the hazards involved.

Cleaning and user maintenance shall not be carried out by children unless they are aged from 8 years and above and supervised. Keep the appliance and its cord out of reach of children aged less than 8 years.

- Children shall not play with the appliance.
- Appliances can be used by persons with reduced physical, sensory or mental capabilities or lack of experience and knowledge if they have been given supervision or instruction concerning use of the appliance in a safe way and understand the hazards involved.
- Children shall not play with the appliance.
- Regularly inspect the supply cord, plug and actual appliance for any damage. If found damaged in any way, immediately cease use of

the appliance and return the entire appliance to the nearest authorised Breville Service Centre for examination, replacement or repair.

- Keep the appliance and accessories clean. Follow the cleaning instructions provided in this book. Any procedure not listed in this instruction booklet should be performed at an authorised Breville Service Centre.

The installation of a residual current device (safety switch) is recommended to provide additional safety protection when using electrical appliances. It is advisable that a safety switch with a rated residual operating current not exceeding 30mA be installed in the electrical circuit supplying the appliance. See your electrician for professional advice.

- Potential injury from misuse.
- Heating element surface is subject to residual heat after use.

NOTICE TO CUSTOMERS REGARDING MEMORY STORAGE

Please note that in order to better serve our customers, internal memory storage has been imbedded into your appliance.

This memory storage consists of a small chip to collect certain information about your appliance including the frequency of use of the appliance and the manner in which your appliance is being used. In the event your appliance is returned for service, the information collected from the chip enables us to quickly and efficiently service your appliance. The information collected also serves as a valuable resource in developing future appliances to better

serve the needs of our consumers. The chip does not collect any information regarding the individuals who use the product or the household where the product is used. If you have any questions regarding the memory storage chip please contact us at privacy@breville.com

SPECIFIC INSTRUCTIONS FOR BES878

- This appliance is recommended for household use only. Do not use this appliance for any purpose other than its intended use. Do not use in moving vehicles or boats. Do not use outdoors.
- If the appliance is to be:
 - left unattended
 - cleaned
 - moved
 - assembled; or
 - stored;

always switch off the espresso machine by pressing the Power button to OFF, switch off at the power outlet and unplug.

- Ensure the product is properly assembled before first use.
- Do not use any other liquid apart from cold mains/town water. We do not recommend the use of highly filtered, de-mineralised or distilled water as this may affect the taste of the coffee and how the espresso machine is designed to function.
- Ensure the portafilter is firmly inserted and secured into the group head before starting an extraction. Never remove the portafilter during the extraction process.
- Do not touch hot surfaces. Allow the product to cool down before moving or cleaning any parts.
- Use caution after milk texturing as the 'Auto

Purge' function may purge hot steam when the steam wand is lowered.

- Use caution when operating machine as metal surfaces are liable to get hot during use.
- Use caution when using the descale feature as hot steam may be released. Before descaling, ensure drip tray is empty and inserted. Refer to the 'Care & Cleaning' section for future instructions.



WARNING

Do not immerse power cord, power plug or appliance in water or any other liquid.

SPECIFIC INSTRUCTIONS FOR WATER FILTER

- Filter cartridge should be kept out of reach of children.
- Store filter cartridges in a dry place in the original packaging.
- Protect cartridges from heat and direct sunlight.
- Do not use damaged filter cartridges.
- Do not open filter cartridges.
- If you are absent for a prolonged period of time, empty the water tank and replace the cartridge.

**FOR HOUSEHOLD USE ONLY
SAVE THESE INSTRUCTIONS**



Components

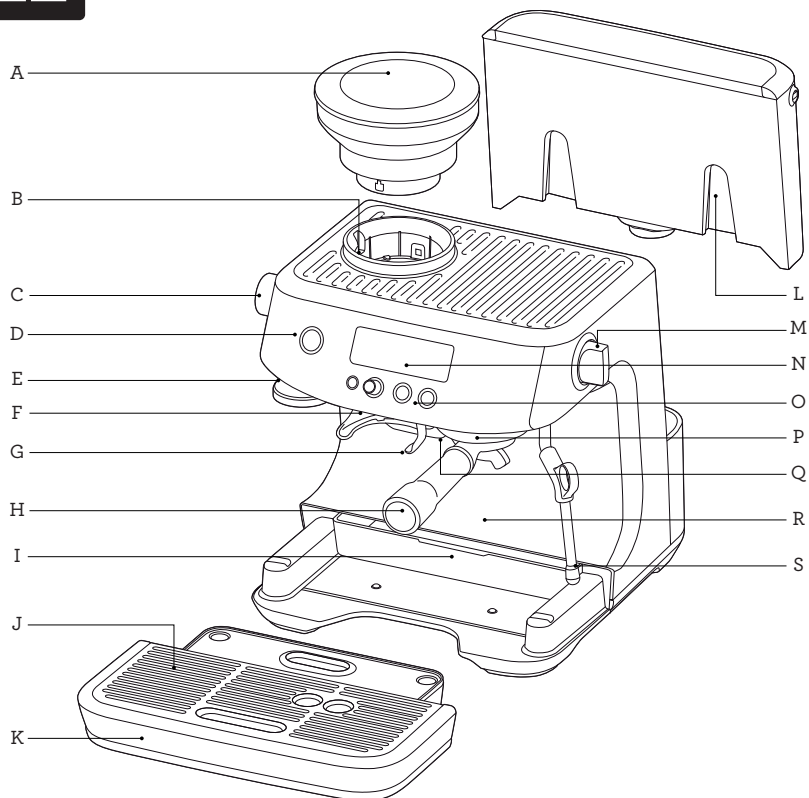

- A. 250g bean hopper
With locking system for easy removal, storage and transfer of coffee beans.
- B. Integrated conical burr grinder
- C. GRIND SIZE selector
30 espresso grind settings from fine to coarse.
- D. POWER button
- E. Integrated removable 54mm tamper
- F. Grinder outlet
- G. Grinding cradle
- H. 54mm stainless steel portafilter
With commercial style spouts.
- I. Storage tray (located behind drip tray)
For storage of accessories.
- J. Removable drip tray grid
- K. Removable drip tray
With tray full indicator.
- L. 2L removable water tank
With replaceable water filters to reduce scale and impurities.
- M. Steam dial
Selector control for steam and hot water.
- N. LCD display
With grinding and extracting progress animations.
- O. Control panel
With MENU, GRIND AMOUNT/ FILTER SIZE, 1 CUP and 2 CUP buttons.
- P. Group head
- Q. Dedicated hot water outlet
For making long blacks and pre-heating cups.
- R. Extra-tall cup clearance
- S. 360° swivel steam wand
Easily adjusts to the perfect position for texturing milk.

All parts of the Barista Pro™ that come into contact with coffee, water and milk are BPA Free.

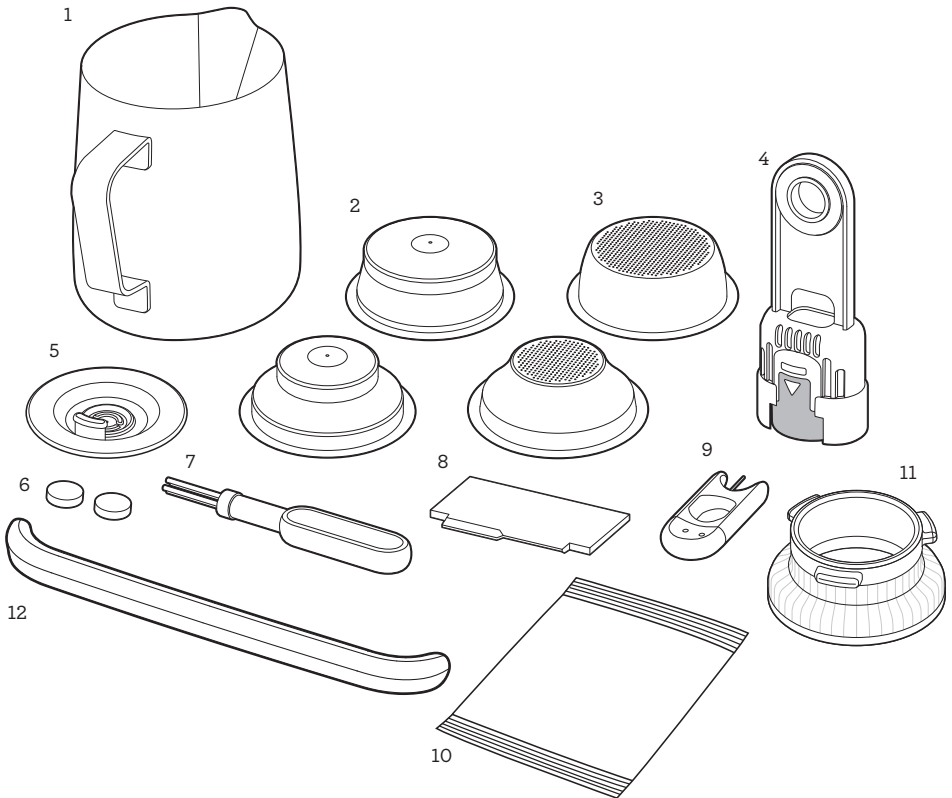

ACCESSORIES

1. Stainless steel milk jug
With MIN and MAX markings.
2. Dual wall filter baskets (1 cup & 2 cup)
Use with pre-ground coffee.
3. Single wall filter baskets (1 cup & 2 cup)
Use when grinding fresh whole coffee beans.
4. Water filter and filter holder
5. Cleaning disc
6. Cleaning tablets
7. Cleaning brush
8. The Razor™ precision dose trimming tool
9. Steam wand and filter basket cleaning tool
10. Descaling powder
11. The Dosing Funnel™ 54
12. Drip tray protection guard cover



Barista Pro™ Features

THERMOJET™ HEATING SYSTEM

Innovative heating system achieves ideal extraction temperature in 3 seconds.

INTEGRATED CONICAL BURR GRINDER

Precision conical burrs maximise ground coffee surface area for a full espresso flavour.

ADJUSTABLE GRIND SIZE

30 espresso grind settings from fine to coarse for optimal extraction.

ADJUSTABLE GRIND AMOUNT

Adjust the amount of fresh ground coffee dosed into the filter basket to suit the fineness or coarseness of the grind.

AUTOMATIC DOSING

The grinder will dispense the required amount of ground coffee for a single or double cup dose.

HANDS FREE GRINDING

Auto stop for hands free grinding directly into the portafilter.

THE RAZOR™ DOSE TRIMMING TOOL

Patented twist blade trims down the puck to the right level for precision dosing and a consistent extraction.

ADJUSTABLE SHOT TEMPERATURE CONTROL

For optimum coffee flavour.

PID TEMPERATURE CONTROL

Electronic PID temperature control for increased temperature stability.

INSTANT HOT WATER

Dedicated hot water outlet for making Long Blacks and pre-heating cups.

LOW PRESSURE PRE-INFUSION

Applies low water pressure at the start of the extraction to gently expand grinds for an even extraction.

VOLUMETRIC CONTROL

Pre-set 1 & 2 cup volumes, manual over-ride or programmable shot volumes.

DRY PUCK FEATURE

Removes excess water from the ground coffee in the filter basket after extraction for easy disposal of the coffee puck.

LARGE DRIP TRAY

With more usable workspace.



Assembly

BEFORE FIRST USE

Machine Preparation

Remove and discard all labels and packaging materials attached to your espresso machine. Ensure you have removed all parts and accessories before discarding the packaging. Remove the packaging and the plastics bags containing the water filter and water filter holder.

Clean the water tank, portafilter, filter baskets, milk jug and drip tray using warm water and a gentle dish washing liquid. Rinse well, then dry thoroughly before reassembling.



NOTE

For machines in colour, attach the provided drip tray protection guard cover to the drip tray. **DO NOT DISCARD.**



Installing the Water Filter

- Remove the water filter and water filter holder from the plastic bag.
- Soak the filter in cold water for 5 minutes.
- Wash the filter holder with cold water.
- Insert the filter into the filter holder.
- Set Date Dial 2 months ahead
- Install the assembled filter holder in the water tank, ensuring it is clicked into place.
- Fill the water tank with cold water before sliding back into position on the back of the machine and locking into place.
- Refer to Care & Cleaning on page 18 for further instruction on installing the filter.



NOTE

DO NOT use highly filtered, demineralised or distilled water in this machine. This may affect the taste of the coffee.



NOTE

For replacement water filters, visit the Breville webpage or contact Breville Customer Service.

Filling the Water Tank

- Ensure the water filter is securely fitted inside the water tank.
- Use the handle at the top of the water tank to assist in lifting it up and away from the machine

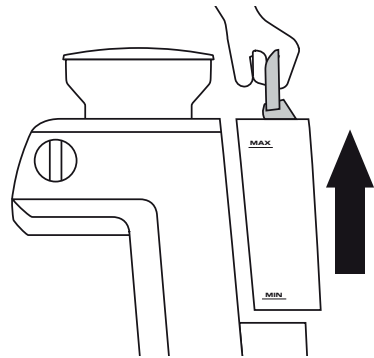

- Fill the water tank with cold potable tap water to below the MAX marking indicated on the side of the water tank.
- Replace the water tank back on the machine, pressing down to ensure that it is properly positioned and attached to the machine.

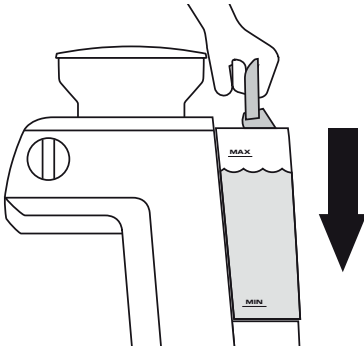

 **NOTE**

Replace the water daily. The water tank should be filled with fresh, cold tap water before each use.

Attaching the Hopper

Insert the bean hopper into position on top of the machine.

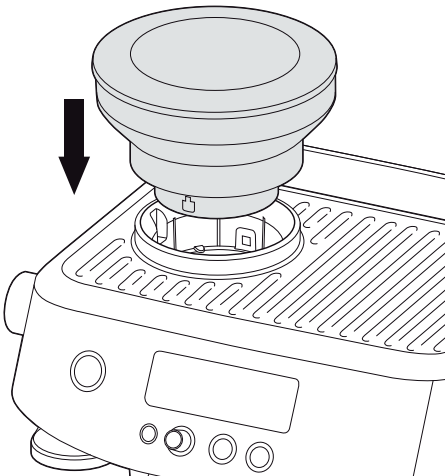

Turn the dial to lock the hopper into place. Fill with fresh coffee beans.

First Use Flush Cycle

A first use cycle must be completed before the initial use of the machine. The first use cycle rinses the machine and primes the heating system.

1. Fill the water tank.
2. Ensure machine is fully assembled with the bean hopper, drip tray and water tank securely attached to the machine.
3. Press the POWER button. The machine will beep and go into FIRST CYCLE mode.
4. The LCD will display FLUSH and the 1 CUP button will be illuminated.

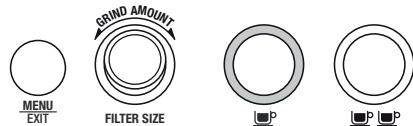
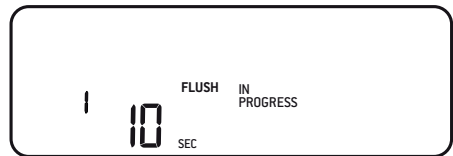

5. Press the 1 CUP button. The LCD will show a count down for the remaining time of the first use cycle.
6. Once complete, the machine will go into READY mode.



Functions

TURNING OFF THE MACHINE

To turn the machine off, press the POWER button. Alternatively, the machine has auto-off, if it is not used for 30 minutes.

FILTER BASKETS

This machine includes 4 filter baskets; 2 x Single Wall and 2 x Dual Wall.

Single Wall filter baskets should be used when grinding fresh whole coffee beans. They allow you to experiment with grind, dose and tamp to create a more balanced espresso.



1 CUP

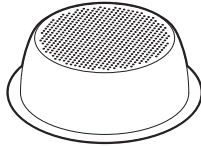

2 CUP

Dual Wall filter baskets should be used when using pre-ground coffee. They regulate the pressure and help to optimise the extraction regardless of the grind, dose and tamp pressure or freshness.



1 CUP



2 CUP

Regardless of whether you use Single Wall or Dual Wall filters baskets, use the 1 CUP basket when brewing a single cup and the 2 CUP basket when brewing two cups or a stronger single cup or mug.

You will need to adjust the grind amount and size if switching from a single to a double basket, or vice versa.

The provided filter baskets are designed for:

1 CUP basket = approx. 8 - 11g

2 CUP basket = approx. 16 - 19g



NOTE

You may need to experiment with how much coffee is dosed into the filter basket or how long the grinder needs to run to achieve the correct dose. For example; when using a finer espresso grind with the Single Wall filter baskets, you may need to increase the grind amount to ensure the filter basket is correctly dosed.

THE GRIND



NOTE

This machine is designed only for whole roasted coffee beans. Avoid grinding unroasted green and under-roasted coffee beans. These are dense and not brittle enough to run through a burr grinder. This will damage or break burr grinders and even pose a safety risk.

When grinding coffee beans, the grind size should be fine, but not too fine. The grind size will affect the rate at which water flows through the ground coffee in the filter basket and the taste of the espresso.

If the grind is too fine (looks like powder and feels like flour when rubbed between the fingers), the water will not flow through the coffee, even when under pressure. The resulting espresso will be **OVER EXTRACTED**, dark in colour and bitter in flavour.

If the grind is too coarse, the water will flow through the ground coffee in the filter basket too quickly. The resulting espresso will be UNDER EXTRACTED and lacking in colour and flavour.

SETTING THE GRIND SIZE

This machine has 30 grind settings to select from, with the size selected displayed on the LCD screen. The default grind size is 15.

When adjusting the grind size, a bar will display on the LCD indicating a faster or slower pour.



Use the GRIND SIZE selector on the left side of the machine to adjust the grind size.

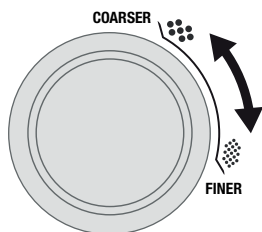

GRINDING COFFEE USING THE DOSING FUNNEL™ 54

- Fill the hopper with fresh coffee beans.
- Insert the required filter basket into the portafilter.
- Attach and twist the dosing funnel onto the portafilter.
- Insert the portafilter (with the dosing funnel) into the grinding cradle.

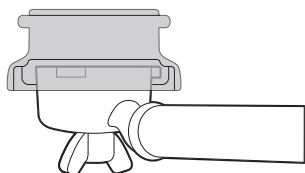

- If required, press the FILTER SIZE button to select the filter basket size; Single or Double.

- If required, turn the GRIND AMOUNT dial to change the grind time; clockwise to increase the time and anti-clockwise to decrease.

NOTE

The default grind times are 9.5 seconds for a 1 cup filter and 13 seconds for a 2 cup filter.

- Press and release the portafilter to activate the automatic dosing. The LCD will show the filter basket filling.



- If you need to pause the grinding function, press and release the portafilter. The LCD will show PAUSED, it will remain paused for 10 seconds before returning to READY mode.
- Press and release the portafilter to resume grinding.

NOTE

It is normal for the portafilter to appear overfilled with ground coffee.

MANUAL DOSING

To manually dose the coffee, press and hold the portafilter in the grinding cradle until the desired amount of ground coffee has been dosed. To stop grinding, release the portafilter. The timer will count up, displaying the grind time.

TAMPING THE GROUND COFFEE

- Remove the portafilter from the grinding cradle.
- Tap the portafilter several times to collapse and distribute the coffee evenly in the filter basket.
- Using the tamper, tamp down firmly (approx. 10-15kgs of pressure). The amount of pressure is not as important as consistent pressure every time.
- After tamping, remove the dosing funnel from the portafilter.

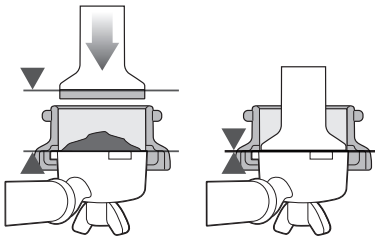

NOTE

As a guide, the top edge of the cap on the tamper should be level with the top of the filter basket AFTER the coffee has been tamped.

NOTE

We recommend quality 100% Arabica beans with a 'Roasted On' date stamped on the bags, not a 'Best Before' or 'Use By' date. Coffee beans are best consumed between 5 - 20 days after the 'Roasted On' date. Stale coffee may pour too quickly from the portafilter and taste bitter and watery.

TRIMMING THE DOSE

The Razor™ precision dose trimming tool allows you to trim the puck to the right level for a consistent extraction.

- Insert the Razor™ dose trimming tool into the filter basket until the shoulders of the tool rest on the rim of the basket. The blade of the dose trimming tool should penetrate the surface of the tamped coffee.

- Rotate the Razor™ dose trimming tool back and forth while holding the portafilter on an angle over a knock box to trim off excess coffee grinds. Your filter basket is now dosed with the correct amount of coffee.



- Wipe excess coffee from the rim of the filter basket to ensure a proper seal is achieved in the group head.

PURGING THE GROUP HEAD

Before placing the portafilter into the group head, run a short flow of water through the group head by pressing the 1 CUP button. This will stabilise the temperature prior to extraction and preheat the portafilter for a consistent shot temperature.

INSERTING THE PORTAFILTER

CAUTION





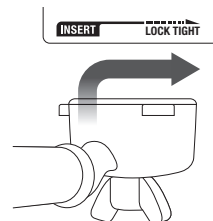



DO NOT insert the portafilter with the dosing funnel in the group-head.

Place the portafilter underneath the group head so that the handle is aligned with the INSERT position. Insert the portafilter into the group head and rotate the handle towards the centre until firm resistance is felt.

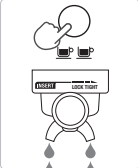

EXTRACTING ESPRESSO

- As a guide the espresso will start to flow after 8-12 seconds (infusion time) and should be the consistency of dripping honey.
- If the espresso starts to flow after less than 7 seconds, you have either under dosed the filter basket and /or the grind is too coarse. This is an **UNDER EXTRACTED** shot.
- If the espresso starts to drip but doesn't flow after 13 seconds, the grind is too fine. This is an **OVER EXTRACTED** shot.

CORRECT EXTRACTION	UNDER EXTRACTION	OVER EXTRACTION
 <ul style="list-style-type: none"> • Flow starts after 8-12 secs • Flow slow like warm honey • Crema is golden brown with a fine mousse texture • Espresso is dark brown 	 <ul style="list-style-type: none"> • Flow starts after 1-7 secs • Flow fast like water • Crema is thin and pale • Espresso is pale brown • Tastes bitter/sharp, weak and watery 	 <ul style="list-style-type: none"> • Flow starts after 13 secs • Flow drips or not at all • Crema is dark and spotty • Espresso is very dark brown • Tastes bitter and burnt
<p>AFTER EXTRACTION</p> <p>REMOVE USED GRINDS Used grinds will form a coffee 'puck'. If the puck is wet, refer to the 'Under Extraction' section.</p>  <p>RINSE FILTER BASKET Keep the filter basket clean to prevent blockages. Without ground coffee in the filter basket, lock the portafilter into the machine and run hot water through.</p> 	<p>SOLUTIONS</p> <div style="display: flex; justify-content: space-around;"> <div data-bbox="415 871 553 1031">  <p>FINE SLOWER EXTRACTION</p> <p>Adjust & re-test</p> </div> <div data-bbox="564 871 702 1031">  <p>INCREASE GRIND AMOUNT</p> <p>Adjust & re-test</p> </div> </div> <p>ALWAYS TAMP TO LINE Adjust & re-test</p> <p>Tamp using 10-15kgs of pressure. The top edge of metal cap on the tamper should be level with the top of the filter basket AFTER tamping. Remove the dosing funnel from the portafilter then trim the puck to the right level using the Razor™ precision dose trimming tool.</p>	<p>SOLUTIONS</p> <div style="display: flex; justify-content: space-around;"> <div data-bbox="729 871 866 1031">  <p>COARSE FASTER EXTRACTION</p> <p>Adjust & re-test</p> </div> <div data-bbox="878 871 1015 1031">  <p>DECREASE GRIND AMOUNT</p> <p>Adjust & re-test</p> </div> </div> <p>ALWAYS TAMP TO LINE Adjust & re-test</p> <p>Tamp using 10-15kgs of pressure. The top edge of metal cap on the tamper should be level with the top of the filter basket AFTER tamping. Remove the dosing funnel from the portafilter then trim the puck to the right level using the Razor™ precision dose trimming tool.</p>

	GRIND	GRIND DOSE	TAMP
OVER EXTRACTED BITTER • ASTRINGENT	Too fine	Too much Use razor to trim	Too heavy
BALANCED	Optimum	8-11g (1 cup) 16-19g (2 cup)	10-15kgs
UNDER EXTRACTED UNDERDEVELOPED • SOUR	Too coarse	Too little Increase dose & use razor to trim	Too light

PRE-PROGRAMMED SHOT VOLUME – 1 CUP

Press the 1 CUP button once, the button will flash, indicating that it has been selected. The LCD will display PRE-INFUSE and the shot clock will start counting up. Once pre-infusion is complete, the shot will start extracting. A pre-set single espresso volume of approx. 30ml will be extracted. The machine will automatically stop once the pre-set volume has been extracted.



PRE-PROGRAMMED SHOT VOLUME – 2 CUP

Press the 2 CUP button once, the button will flash, indicating that it has been selected and the LCD will display PRE-INFUSE and the shot clock will start counting up. Once pre-infusion is complete, the shot will start extracting. A pre-set double espresso volume of approx. 60ml will be extracted. The machine will automatically stop once the pre-set volume has been extracted.



MANUAL PRE-INFUSION & EXTRACTION

Press and hold the 1 CUP or 2 CUP button for the desired pre-infusion time. Release the button to commence the extraction. Press the flashing button to stop the extraction.

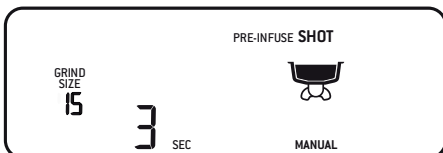

PROGRAMMING ESPRESSO SHOT

- Press the MENU button to enter the main menu.

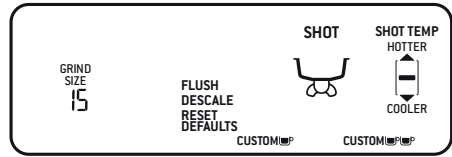

- Use the GRIND AMOUNT dial to navigate through the menu to the custom button or custom button. To select, press the dial.
- Press the desired CUP button to start the default pre-infusion. To customise the pre-infusion, press and hold the same CUP button for the desired pre-infusion time. Release the button to commence the extraction.
- To stop the extraction at the desired level, press the CUP button. The LCD and CUP button will stop flashing and the machine will beep to indicate that the custom setting has been remembered. The machine will then return to READY mode. The custom setting can now be activated by pressing the desired CUP button selected.

ADJUSTING SHOT TEMPERATURE

- Press the MENU button to enter the main menu.
- Use the GRIND AMOUNT dial to navigate the menu and press to select SHOT TEMP.



- Use the GRIND AMOUNT dial to increase or decrease the shot temperature as displayed on the LCD.
- Press the dial to confirm the desired temperature. The machine will return to READY mode.

RESETTING TO DEFAULTS

- Press the MENU button to enter the main menu.
- Use the GRIND AMOUNT dial to navigate the menu and select RESET DEFAULTS.
- The machine will beep.
- The GRIND AMOUNT, FILTER SIZE, SHOT TEMP, 1 CUP and 2 CUP SHOT settings will all return to the default settings. The machine will return to READY mode.

USING HOT WATER OUTLET

The hot water function can be used to pre-heat cups or to add hot water manually.

To activate the hot water, turn the STEAM dial to .

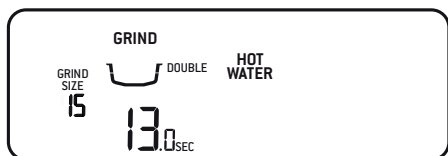

- The LCD will show that HOT WATER has been activated.
- To stop the hot water, turn the dial back to the centre, vertical position.
- The hot water will stop after 60 seconds, but the dial must be turned back manually to the standby position.

TEXTURING MILK

It is recommended to momentarily purge the steam wand prior to texturing milk.

Position the steam wand over the drip tray and turn the STEAM dial to the . The LCD will display STEAM when activated. Turn the STEAM dial back to a vertical position to stop steaming.

Different brands and types of milk and milk alternatives will texture differently.

- Start with fresh cold milk.
- Fill the milk jug to between the MIN and MAX markings.
- Lift the steam wand and insert into the milk jug with the steam wand tip 1-2cm below the surface of the milk, close to the right-hand side of the jug at a 3 o'clock position.

- Turn the STEAM dial to the .
- Keep the steam wand tip just under the surface of the milk until the milk is spinning clockwise, producing a vortex (whirlpool effect).
- With the milk spinning, slowly lower the jug. This will bring the steam wand tip to the surface of the milk and start to introduce air into the milk.
- Gently break the surface of the milk with the tip to get the milk spinning fast enough.
- Keep the steam wand tip at or slightly below the surface, continuing to maintain the vortex. Texture the milk until sufficient volume is obtained.
- Lift the jug to lower the tip beneath the surface but keep the vortex spinning. The milk is at the correct temperature (60-65°C) when the jug is hot to touch.



- Once the desired temperature has been achieved, turn the STEAM dial back to the vertical position.
- Remove the steam wand from the milk jug.
- Wipe the steam wand with a clean, damp cloth. Then return to lowered position over the drip tray.



CAUTION: BURN HAZARD

Pressurised steam can still be released, even after machine has been switched off. Children must always be supervised.



NOTE

Ensure the STEAM dial is in the vertical position before removing the steam wand from the milk jug.



NOTE

When the machine creates steam, a pumping noise can be heard. This is normal operation.



NOTE

Use only the supplied stainless steel milk jug to froth milk using this machine. The use of other containers may lead to dangerous conditions.

STEAM WAND PURGING

After texturing milk, it is recommended to purge the steam wand. With the steam wand positioned over the drip tray and turn the STEAM dial to the  and allow the machine to purge. Turn the STEAM dial back to a vertical position to stop steaming.

ADJUSTING CONICAL BURRS

Some types of coffee may require a wider grind range to achieve an ideal extraction or brew. A feature of your Barista Pro™ is the ability to extend this range with an adjustable upper burr. We recommend making only one adjustment at a time.



1 Unlock hopper

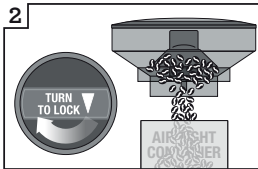

2 Hold hopper over container & turn dial to release beans into container

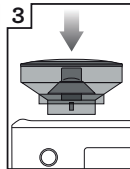

3 Align hopper into position

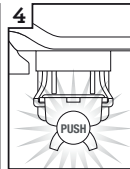

4 Run grinder until empty

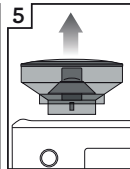

5 Remove hopper



6 Remove upper burr

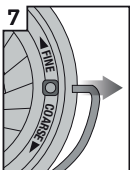

7 Remove wire handle from both sides of the burr

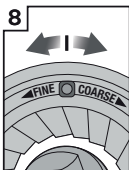

8 Move adjustable top burr, 1 number coarser or finer



9 Align the number with the handle opening

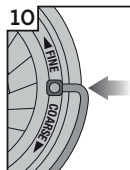

10 Insert wire handle from both sides of the burr

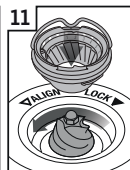

11 Push upper burr firmly into position

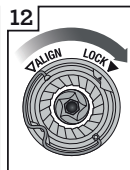

12 Lock upper burr

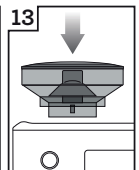

13 Align hopper into position



14 Lock hopper

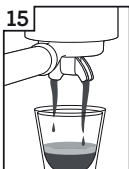

15 Check your extraction



Care & Cleaning



CAUTION:

To prevent damage to the appliance, do not use alkaline cleaning agents when cleaning, use a soft cloth and mild detergent.

REPLACING THE WATER FILTER

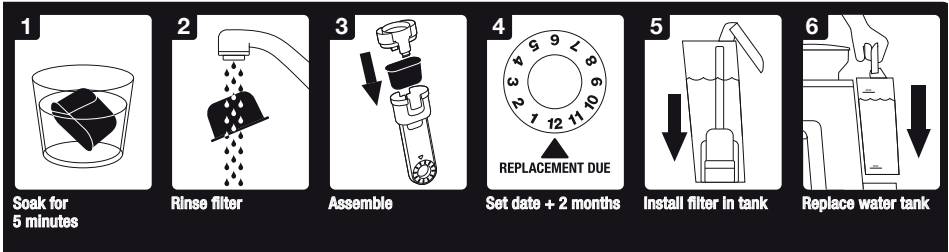

The water filter provided helps to prevent scale build up which over time can affect the performance of your machine. Replacing the water filter every 2 months will reduce the need to de-scale the machine.

If you live in a hard water area, we recommend changing the water filter more frequently.

- Remove the water filter from the plastic bag.
- Soak the filter in cold water for 5 minutes.
- Rinse the filter under cold running water.
- Insert the filter into the filter holder.
- Set Date Dial 2 months ahead
- Install the assembled filter holder in the water tank, ensuring it is locked into place.
- Fill the water tank with cold water before sliding back into position on the back of the machine and locking into place.



NOTE

Replacement water filters can be purchased from the Breville website or by contacting Breville customer service.

FLUSH CLEANING CYCLE

The LCD will display a FLUSH alert when a cleaning cycle is required. The cleaning cycle is separate from descaling.

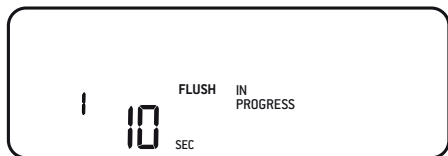

1. Insert the cleaning disc into the filter basket in the portafilter.
2. Place a cleaning tablet on top of the cleaning disc.
3. Lock the portafilter into the group head.
4. Empty the drip tray and replace onto the machine.
5. Fill the water tank to the MAX line then reattach to the machine.
6. Press the MENU button to enter the main menu.
7. Use the GRIND AMOUNT dial to navigate the menu to FLUSH, then press to select. The 1 CUP button will illuminate.
8. Press the 1 CUP button to start the cleaning cycle. The remaining time for the cleaning cycle will be displayed on the LCD.
9. Once the cleaning cycle is complete, the machine will beep and return to READY mode. If any of the cleaning tablet remains in the cleaning disc, repeat the cycle.
10. Empty and rinse the portafilter, cleaning disc and drip tray.

DESCALING



NOTE

Ensure that the water filter is removed from the water tank before adding the descaling powder when descaling the machine.

After regular use, hard water can cause mineral build up in and on many of the inner functioning components, reducing the brewing flow, brewing temperature, power of the machine, and the taste of the espresso. The LCD will display a DESCALE alert, when a descaling cycle is required.

1. Empty the drip tray and reattach to the machine. Remove the water tank from the machine and remove the filter from the water tank.
2. Fill the water tank to the DESCALE line indicated and add the descaling agent to the water. Reattach the water tank to the machine.
3. Press the MENU button to enter the main menu. Use the GRIND AMOUNT dial to navigate the menu to DESCALE, then press to select. The 1 CUP button will illuminate.
4. Press the 1 CUP button to start the descaling cycle. The descale cycle cleans in 3 stages; coffee, hot water and steam. After each stage is complete, the machine will beep. The STEAM DIAL must be manually turned to the HOT WATER and STEAM position when indicated on the LCD.

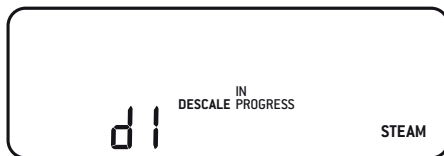

5. Once the descale cycle is complete, the machine needs to complete a rinse cycle. The 1 CUP button will illuminate. As with the descale cycle, the STEAM DIAL must be manually turned to correct position when indicated on the LCD.
6. Remove and empty the drip tray then replace onto the machine. Empty any remaining descaling liquid from the water tank, then fill the water tank to the MAX line and reattached to the machine.
7. Press the 1 CUP button to commence the rinse cycle. The rinse cycle is also 3 stages. The LCD will show which stage it is up to. After each stage, the machine will beep.
8. Once the rinse cycle is complete, the machine will beep and return to READY mode.
9. Remove and rinse the drip tray and water tank. Dry thoroughly before replacing them on the machine.

CLEANING THE CONICAL BURR GRINDER

This grinder cleaning cycle removes oil build-up on the burrs which can impede performance.

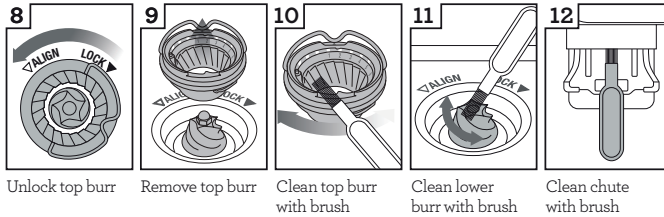
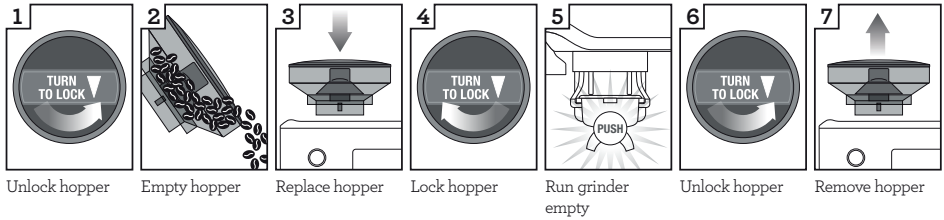

ADVANCED CLEANING FOR THE CONICAL BURR GRINDER

This step is only required if there is a blockage between the grinding burrs and the grinder outlet.

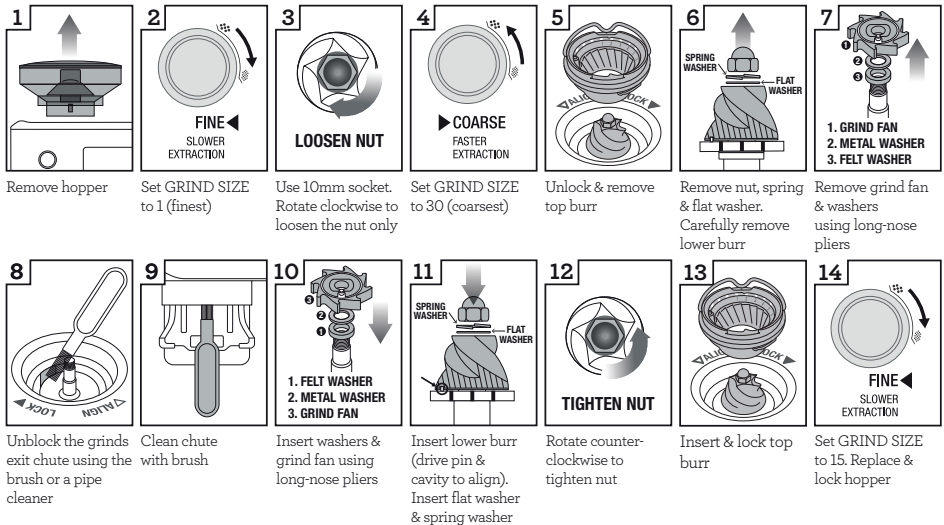

WARNING

Care should be taken as the grinder burrs are extremely sharp.

CLEANING THE STEAM WAND

- The steam wand should always be cleaned after texturing milk. Wipe the steam wand with a damp cloth.
- After use, it is recommended to purge the steam wand for a couple of seconds, to clear any remaining milk. With the steam wand positioned down over the drip tray, turn the STEAM dial to  for a couple of seconds allow the machine to create steam for a couple of seconds before turning it back to the vertical position.
- If the steam tip hole becomes blocked, it will reduce frothing performance. Use the provided steam wand cleaning tool to clear the opening.
- If the steam wand is still blocked, use the spanner in the middle of the steam wand cleaning tool to unscrew the tip. Soak the tip in hot water before using the cleaning tool to unblock again. Replace the tip back on the steam wand, using the tool.

CLEANING THE FILTER BASKETS AND PORTAFILTER

- The filter baskets and portafilter should be rinsed under hot water immediately after use to remove all residual coffee oils.
- If any of the holes in the filter basket become blocked, use the pin on the end of the provided cleaning tool to unblock the holes.
- If the holes remain blocked, dissolve a cleaning tablet in hot water and soak filter basket and portafilter in solution for approx. 20 minutes. Rinse thoroughly.

CLEANING THE GROUP HEAD

- The group head interior and shower screen should be wiped with a damp cloth after use to remove any ground coffee particles.
- Periodically purge the machine. Place an empty filter basket and portafilter into the group head. Press the 1 CUP button and run a short flow of water to rinse out any residual coffee. Press the 1 CUP button again to stop the hot water. Remove the portafilter and rinse thoroughly.

CLEANING THE DRIP TRAY

- The drip tray should be removed, emptied, and cleaned at regular intervals, particularly when the drip tray full indicator is visibly floating.
- Remove the grid from the drip tray. Lift the coffee grind separator and dispose of any coffee grounds. The drip tray full indicator can also be removed from the drip tray by pulling upwards to release the side latches. Wash all parts in warm soapy water with a soft cloth. Rinse and dry thoroughly.
- The storage tray (located behind the drip tray) can be removed and cleaned with a soft, damp cloth. Do not use abrasive cleansers, pads or cloths which can scratch the surface.



NOTE

All parts should be cleaned by hand using warm water and a gentle dish washing liquid. Do not use abrasive cleansers, pads or cloths which can scratch the surface. Do not clean any of the parts or accessories in the dishwasher.



WARNING

Do not immerse the power cord, power plug or appliance in water or any other liquid.

CLEANING THE OUTER HOUSING

Wipe the outer housing with a soft, damp cloth and then polish with a soft, dry cloth.

STORING YOUR MACHINE

Before storing, press the POWER button to turn the machine off then turn off and remove the plug from the power outlet. Remove unused beans from the hopper, clean the grinder (see page 18), empty the water tank and the drip tray. Ensure the machine is cool, clean and dry. Place accessories in the storage tray.

Store the machine upright and do not store anything on top.

ERROR MODE

If your machine displays  on the LCD, contact Breville Customer Service.



Troubleshooting

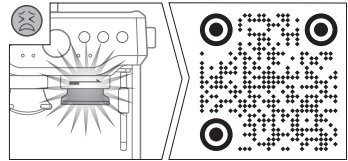

ANZ - QR47

PROBLEM	POSSIBLE CAUSES	EASY SOLUTION
Water does not flow from the group head. No hot water.	Water tank is empty.	Fill tank.
	Water tank is not fully inserted and locked into position.	Push water tank down completely to lock into place.
	Machine needs to be descaled.	Perform descale cycle.
	Coffee is ground too finely and/or too much coffee in filter basket and/or over tamping and/or filter basket is blocked.	See below, 'Espresso only drips from the portafilter spouts or not at all'.
Espresso only drips from the portafilter spouts or not at all.	Coffee is ground too finely.	Use slightly coarser grind. Refer to 'Setting the Grind Size', page 12 and 'Over Extraction', page 14.
	Too much coffee in the filter basket.	Lower dose of coffee. Refer to 'Dosing', page 12 and 'Over Extraction', page 14. After tamping, trim the coffee dose using the Razor™ dose trimming tool.
	Coffee tamped too firmly.	Tamp between or 10-15kgs of pressure.
	Water tank is empty.	Fill tank.
	Water tank is not fully inserted and locked into position.	Push water tank down completely to lock into place.
	The filter basket may be blocked.	Use the pin on the end of the provided cleaning tool to unblock the hole(s). If the hole(s) remain blocked, dissolve a cleaning tablet in hot water and soak filter basket and portafilter in solution for approx. 20 minutes. Rinse thoroughly.
	Machine needs to be descaled.	Perform descale cycle.
Water doesn't come through (the machine makes loud noise).	Water tank is empty or water level is below MIN.	Fill tank.

PROBLEM	POSSIBLE CAUSES	EASY SOLUTION
Espresso runs out too quickly.	Coffee is ground too coarsely.	Use slightly finer grind. Refer to 'Setting the Grind Size', page 12 and 'Under Extraction', page 14.
	Not enough coffee in the filter basket.	Increase dose of coffee. Refer to 'Dosing', page 12 and 'Under Extraction', page 14. Tamp then use the Razor™ dose trimming tool to trim off excess coffee.
	Coffee tamped too lightly.	Tamp between 10-15kgs of pressure.
Espresso runs out around the edge of the portafilter.	Portafilter not inserted in the group head correctly.	Ensure portafilter is completely inserted and rotated until resistance is felt.
	There are coffee grounds around the filter basket rim.	Clean excess coffee from the rim of the filter basket to ensure a proper seal in group head.
	Too much coffee in the filter basket.	Lower dose of coffee. Refer to 'Dosing', page 14. After tamping, trim the coffee dose using the Razor™ dose trimming tool.
No steam.	Machine has not reached operating temperature.	Allow time for the machine to reach operating temperature.
	Water tank is empty.	Fill tank.
	Water tank is not fully inserted and locked into position.	Push water tank down completely to lock into place.
	Machine needs to be descaled.	Perform descale cycle.
	Steam wand is blocked.	Refer to 'Cleaning the Steam Wand', page 21.
Pulsing/pumping sound while extracting espresso or steaming milk.	The machine is carrying out the normal operation of the pump.	No action required as this is the normal operation of the machine.
	Water tank is empty.	Fill tank.
	Water tank is not fully inserted and locked into position.	Push water tank down completely to lock into place.

PROBLEM	POSSIBLE CAUSES	EASY SOLUTION
Coffee not hot enough.	Cups not pre-heated.	Rinse cups under hot water outlet.
	Portafilter not pre-heated.	Rinse portafilter under hot water outlet. Dry thoroughly.
	Milk not hot enough (if making a cappuccino or latté etc).	Texture milk for a longer period of time.
	Water temperature needs to be adjusted.	Increase the brew temperature refer to 'Adjusting Shot Temperature' page 15.
No crema.	Coffee tamped too lightly.	Tamp between 8-10kgs of pressure.
	Coffee is ground too coarsely.	Use slightly finer grind. Refer to 'Setting the Grind Size', page 12 and 'Under Extraction', page 14.
	Coffee beans or pre-ground coffee are not fresh.	If grinding fresh whole coffee beans, use freshly roasted coffee beans with a 'Roasted On' date and consume between 5-20 days after that date. If using pre-ground coffee, use within a week of grinding.
	The filter basket may be blocked.	Use the pin on the end of the provided cleaning tool to unblock the hole(s). If the hole(s) remain blocked, dissolve a cleaning tablet in hot water and soak filter basket and portafilter in solution for approx. 20 minutes. Rinse thoroughly.
	Single Wall filter baskets are being used with pre-ground coffee.	Ensure you use Dual Wall filter baskets with pre-ground coffee.
Water leaking	Water tank is not fully inserted and locked into position.	Push water tank down completely to lock into place.

PROBLEM	POSSIBLE CAUSES	EASY SOLUTION
Machine is on but ceases to operate.	The safety thermal-cut out may have activated due to the pump or grinder overheating.	Press the POWER button to switch the machine off and unplug from the power outlet. Allow to cool for about 30-60 minutes. If problem persists, call Breville Support.
No ground coffee coming from grinder.	No coffee beans in hopper.	Filler hopper with fresh coffee beans.
	Blocked grinder chamber or chute.	Clean and clear grinder chamber and chute. Refer to 'Advanced Cleaning for the Conical Burr Grinder', page 20.
	Water / moisture in grinder chamber and chute.	Clean and clear grinder chamber and chute. Refer to 'Advanced Cleaning for the Conical Burr Grinder', page 20. Ensure burrs are thoroughly dry before re-assembling. It is possible to use a hair dryer to blow air into the grinder chamber.
Too much/too little ground coffee is being delivered to the filter basket.	Grind amount settings are incorrect for particular grind size.	Use the grind duration button to increase or decrease the grind amount. Refer to 'Dosing', page 12 and 'Extraction Guide', page 14.
Too much/too little espresso is being delivered to the cup.	Grind amount and/or grind size settings and/or shot volumes require adjustment.	Adjust the grind amount and/or grind size settings. Refer to 'Setting the Grind Size', page 12, 'Dosing', page 12 and 'Extraction Guide', page 14.
Grinder is making a loud noise.	Blockage or foreign object in grinder.	Remove hopper, check for debris or blockage. If necessary, clean and clear grinder chamber and chute. Refer to 'Cleaning the Conical Burr Grinder', page 20.



Notes

Breville Service Centre

Australian Customers

Phone: 1300 139 798

Web: www.breville.com

New Zealand Customers

Phone: 0800 273 845

Web: www.breville.com

Breville®

Master Every Moment™

Breville, the Breville Logo, Barista Express and Temp Control are trademarks of Breville Pty Ltd ("Breville") and Breville's products are distributed in Australia and New Zealand under license.

Copyright Breville Pty. Ltd. 2023.

Due to continued product improvement, the products illustrated/photographed in this brochure may vary slightly from the actual product.